

# ÜRÜN KATALOĞU



**AKAD**  
MAKİNE & HIRDAVAT TİC.LTD.ŞTİ.

## Değerli İş Ortaklarımız ;

Akad Makine 2014 yılında Pvc ve Alüminyum profil işleme sektöründe 15 yılı aşkın satış ve teknik bilgiye sahip bir ekip tarafından İSTANBUL' da kurulmuştur.

Sektöre hakim uzman kadromuz ile sektöre yön veren firmaların yetkili satış bayilikleri bünyesinde yurt içi ve yurtdışı satışlar yapmaktayız.

### Hizmetlerimiz ;

Profesyonel makine ihtiyaçlarınızda kalite , fiyat ,garanti ve uygunluk kriterlerini değerlendirmenize yardımcı olarak sizin için en uygun olan ürünü tedarik edip , satış sonrası yedek parça ve teknik konularda hizmet veriyoruz.

Makinelerinizde kullanılan kesici takım ( testere ,freze, temizleme ve kertme bıçakları v.b ) ihtiyaçlarınızı alternatif marka çeşitleri , gerekirse özel ölçülerinizde tedarik ediyoruz.

Sektör ayırt etmeden çalışan atölyelerinizin tüm hırdavat ve sarf malzeme ihtiyaçlarınızı alternatif marka seçenekleri üzerinden siz değerli müşterilerimize sunuyoruz.

İŞ ORTAKLARIMIZA

**PROFESYONEL**  
**HİZMETLER SUNUYORUZ.**

Sadece söylediklerinizi değil, her zaman daha fazlasını yapın, sorumluluk alın, değer yaratın ve değer katın...



MİSYONUMUZ

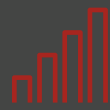

**Creative**  
**Marketing**

Sektörde ki en kaliteli markalar ile en hızlı hizmeti tarafınıza sunuyoruz. Bizim için 'müşteri' yoktur , 'İş Ortağı' vardır.

Ürünler Hakkında Detaylı Bilgi Almak İçin Web Sitemizi Ziyaret Edin ;

[www.akadmakine.com.tr](http://www.akadmakine.com.tr)

Bizimle İletişime Geçin : 0 (216) 484 57 67  
Whatsapp İletişim Hattı : 0 (534) 085 03 13

# İçindekiler



PVC ve Alüminyum  
Profil İşleme Makineleri

Syf / 1-8

- PVC ve Alüminyum Profil İşleme Makineleri
- Yedek Parçalar
- Kompresörler
- Atölye Ekipmanları



TESTERELER

Syf / 9-14

- Elmas Uçlu Alüminyum ve Pvc Kesme Daire Testereleri
- Pvc Çıta Kesme Testereleri ve 45 Freze
- Orta Kayıt Alıştırma Testereleri
- Elmas Uçlu Alucobond Testereler
- Metal Profil Kesme Testereleri
- Elmas Uçlu Trapez Testereler
- Elmas Uçlu Ahşap Testereler
- Bi Metal Şerit Testereler

SCHWERT **KÖNIG** freud

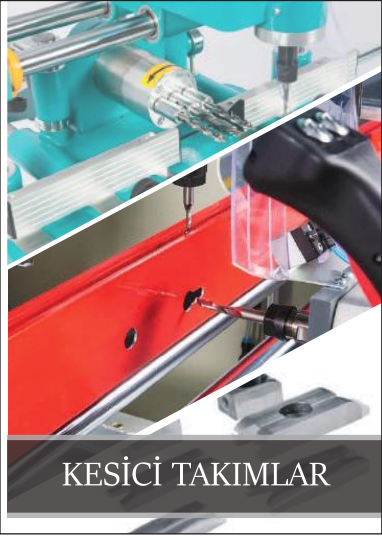

KESİCİ TAKIMLAR

Syf / 15-21

- Frezeler
- 3'lü Kol Yeri Delme Uç Takımları
- Pvc Yüzey ve İç Kazıma Bıçakları

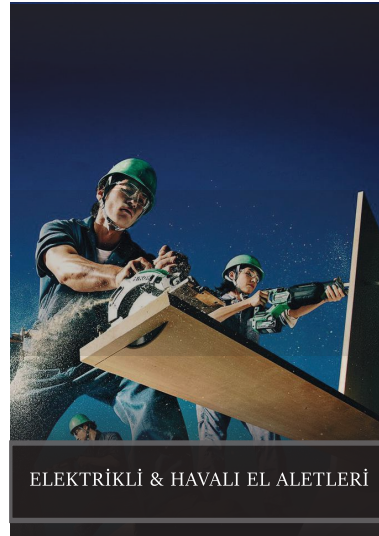

ELEKTRİKLİ & HAVALI EL ALETLERİ

Syf / 22-26

- Elektrikli El Aletleri
- Havalı El Aletleri
- Hava Hortumları
- Pnömatik Bağlantı Elemanları

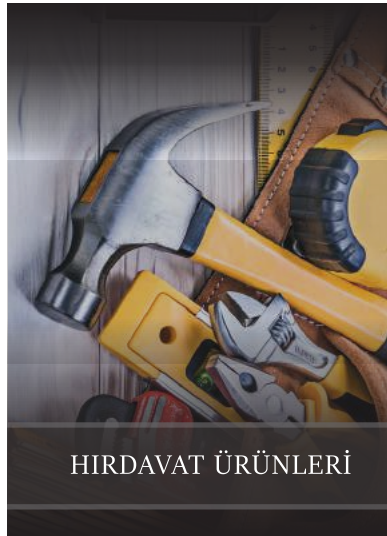

HIRDAVAT ÜRÜNLERİ

Syf / 26-36

- Camcı Aksesuarları
- Tabanca Grubu
- Çekiç - Tokmak Grubu
- Panç Grubu
- Ölçüm Grubu
- El Aletleri
- SDS - HSS Matkap Uçları
- Bits Uçlar
- Kesici ve Taşlama Grubu
- İş Güvenliği Aksesuarları
- Ambalaj Ürünleri



AKSESUARLAR

Syf / 37-39

- Kapı Kolları
- Boru Kolları
- Pencere Kolları
- Mentешeler
- Sürgüler
- Diğer Aksesuarlar
- Alüminyum Profil

**İKAR**

[www.akadmakine.com.tr](http://www.akadmakine.com.tr)

Bizimle İletişime Geçin : 0 (216) 484 57 67  
Whatsapp İletişim Hattı : 0 (534) 085 03 13

**AKAD**  
MAKİNE  
Ticaret Limited Şirketi

# PVC ve Alüminyum Profil İşleme Makineleri

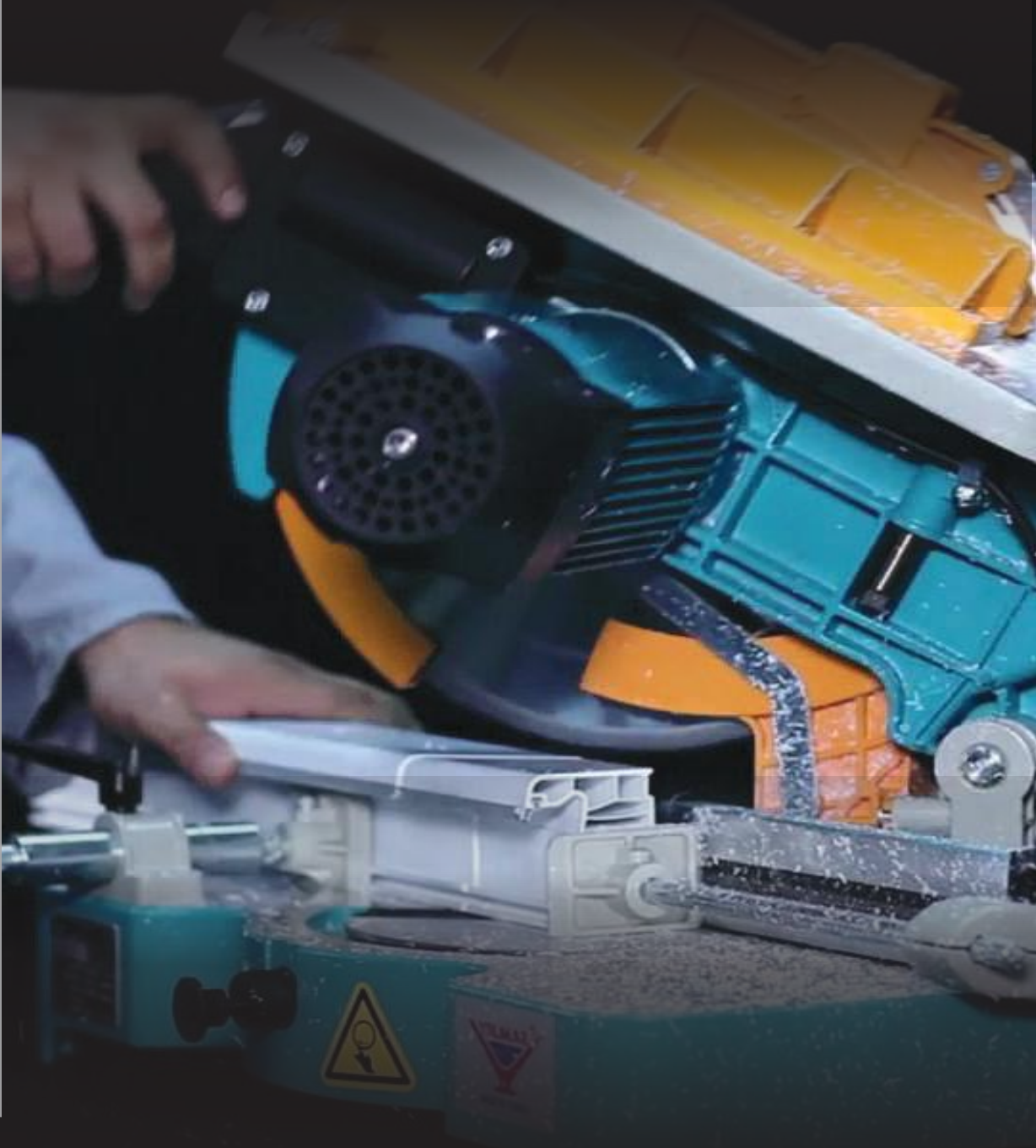

0 216 484 57 67

info@akadmakine.com

www.akadmakine.com.tr





KD250

PVC, alüminyum ve ahşap profillerin düz ve dereceli kesme işlemleri için tasarlanmış, portatif kesme makinesidir.



KD 305

KD 305 PVC, alüminyum ve ahşap profillerin düz ve dereceli kesme işlemleri için tasarlanmış, portatif kesme makinesidir.



KY 305

KY 305 PVC, alüminyum ve ahşap profillerin düz ve dereceli kesme işlemleri için tasarlanmış, portatif kesme makinesidir.



FR 222

Menteşe, kol yeri ve barel yuvası delikleri ile ispanyolet ve kilit yuvası açma gibi bir çok frezeleme ve delik delme işlemleri için kullanılır.



FR 223

Menteşe, kol yeri ve barel yuvası delikleri ile ispanyolet ve kilit yuvası açma gibi birçok frezeleme ve delik delme işlemleri için kullanılır.



KM 212

Alüminyum ve PVC profilleri hassas bir biçimde alıştırma (kertme) işlemlerinde kullanılan manuel olarak çalışan portatif kesme makinesidir.



KD 400P

KD 400D ve KD 400PS, alüminyum ve PVC profillerin düz ve dereceli kesme işlemleri için tasarlanmış kesme makinesidir.



MKN300

Kesme makinelerinde profillerin istenilen ölçüde kesilmesine yardımcı olan manuel ayarlamalı konveyördür.

PY 100

38mm



Ø 12 mm.

PY 101

32 mm



20 mm.

PY 102

19/25mm



Ø 10.5mm.

Ø 8.5mm.

PY 104

22mm



Ø 11mm.



PY SERİSİ

Alüminyum profillerin köşe bağlantıları için slot açmaya yarayan manuel prestir.



ACK550

- ▶ ACK 550 geniş ebatlı alüminyum profilleri, düz veya dereceli olarak,
- ▶ Ø 550 mm testere ile kesmek amacı ile tasarlanmış, kesme makinesidir.
- ▶ Çift el kumanda uygulaması
- ▶ 75°, 60°, 45°, 30°, 22.5°, 15°, 0° açılarda sağ ve sol yönde susta ile kesim
- ▶ -75° sol ve +75° sağ ara derecelerde hassas kesim
- ▶ Hidro-pnömatik kontrollü testere hareketi
- ▶ Ayarlanabilir testere çıkış hızı
- ▶ Kabin içi LED aydınlatma
- ▶ Pnömatik olarak açılan koruma kapağı



CRM250S

- ▶ 1 ad. dikey ve 2 adet yatay kopya freze motoru mevcuttur.
- ▶ Alüminyum profil çevirmeden 3 tarafını hızlı ve hassas olarak işleyebilmektedir.
- ▶ 2 adet dikey ve 2 adet yatay olmak üzere 4 adet pnömatik mengene bulunmaktadır.
- ▶ Yatay ve dikey şablon izleyici uçlar pnömatik olup Ø 5, Ø 8 ve Ø 10 olarak
- ▶ 3 farklı çapları mevcuttur.
- ▶ Yatay ve dikey olarak konumlanmış standart operasyonları içeren yatay ve dikey şablonları operasyonları kolaylaştıran yüksek hassasiyetli yataklama sistemi, gaz amortisörler ve ergonomik kol tasarımı.
- ▶ Sağ ve sol tarafta konveyör, sağ konveyörde cetvel ve dayama sistemi mevcuttur.
- ▶ Sprey takım soğutma sistemi.



KM215

- Alüminyum ve PVC profilleri hassas bir biçimde alıştırma işlemlerinde kullanılan Hidro-pnömatik olarak çalışan kертme makineleridir.
- ▶ Hidro-pnömatik freze hareketi ile kaliteli kертme operasyonları
  - ▶ Çalışmayı kolaylaştıran seri bıçak değiştirme özelliği
  - ▶ 4 farklı profile göre dayama sistemi
  - ▶ Orta kayıt profillerin 45° - 90° arasında kертme işlemi
  - ▶ Koruma kapağı ile güvenli çalışma
  - ▶ Bıçak muhafaza yeri
  - ▶ Burç malzemeler ile ayarlanabilir kesme derinliği
  - ▶ Pnömatik mngeneler ile iş parçası güvenli olarak bağlanır
  - ▶ Sağlam makine şasesi
  - ▶ Kертme profil ölçüleri (HxW): 90x236 mm
  - ▶ Maksimum testere çapı: Ø160 mm
  - ▶ Bağlanabilir profil ölçüleri (H x W): 160 x 236mm

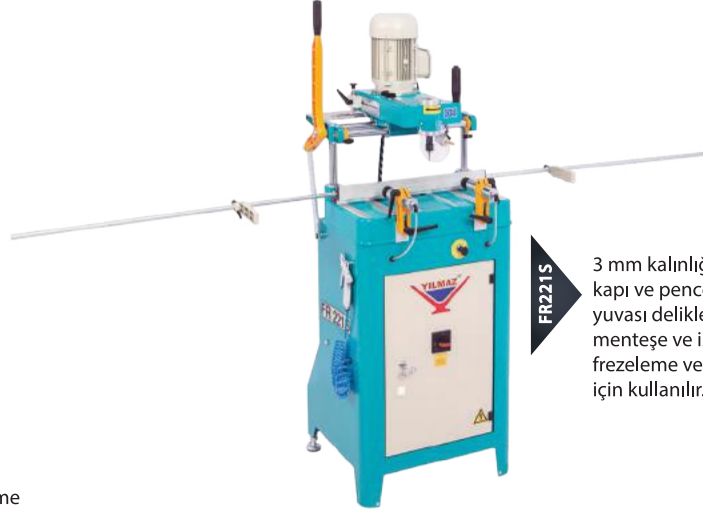

FR221S

3 mm kalınlığa kadar PVC ve Alüminyum kapı ve pencere profillerindeki, barel yuvası delikleri, su tahliye kanalları, menteşe ve ispanyolet yeri gibi birçok frezeleme ve delik delme işlemleri için kullanılır.

- ▶ Menteşe, kol yeri ve barel yuvası delikleri ile ispanyolet ve kilit yuvası açma gibi birçok frezeleme ve delik delme işlemleri için kullanılır.
- ▶ Dökme alüminyum gövde
- ▶ Krom kaplı paslanmaz yataklama milleri
- ▶ Çelik sacdan üretilmiş makine sehpa
- ▶ Kaplamalı saç metal şablon
- ▶ 2x manuel izleyici pin
- ▶ Ø5 kesici takım monte edilmiş
- ▶ Bağlanabilir profil ölçüleri: W max.: 130, W min.: 10, H max.: 130, H min.: 20 mm

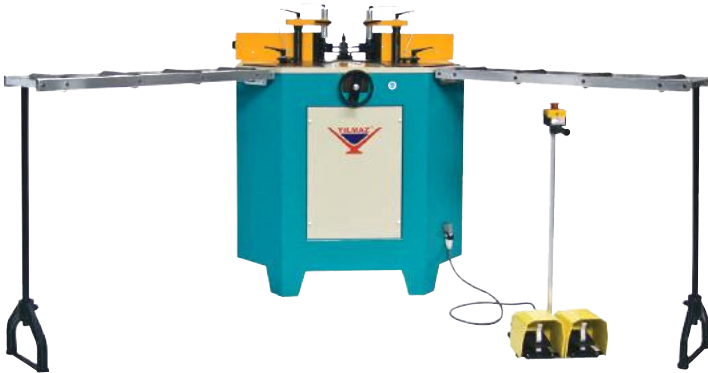

KP120

- KP 120 alüminyum profillerin doğru bir şekilde köşelerinin hidrolik yolla preslenerek birbirlerine monte edilmesi amacı ile dizayn edilmiştir. Makine yarı otomatik ve manuel kontrollü olarak çalışmakta olup operatörün çalışma alanının dışında güvenlikli alanda tutulmasına dikkat edilmiştir.
- ▶ Tamamen hidrolik presleme prensibine sahiptir.
  - ▶ Kuvvetli ve uzun ömürlü çelik malzemeden üretilmiş makine tablasına sahiptir.
  - ▶ Profillerin şekline ve yüksekliğine göre kolay ayarlanabilir ve monte edilebilir takım sistemi.
  - ▶ Hidrolik silindirelerin ilerlemesi ve profil dayama milimetrik cetvel sistemi ile ayarlanabilmektedir.
  - ▶ Makine pnömatik (mngeneler için) ve hidrolik (presleme için) iki adet ayak pedali sayesinde çalışma döngüsünü tamamlamaktadır.
  - ▶ Presleme işlemi birbiri ile senkronize olarak hareket eden hidrolik presleme kafaları sayesinde olmaktadır.
  - ▶ Güçlü hidrolik pompa sistemi (5 ton x 2)
  - ▶ Profilin yüzeyini korumak için Polyamid levhalar
  - ▶ Piston 'return' butonu sayesinde presleme silindirlerini iş parçasına yakın olarak pozisyonlamak mümkündür.
  - ▶ Birleştirilebilecek maksimum profil yüksekliği 130 mm dir.
  - ▶ 180 mm profil yüksekliği için gerekli ilave ekipmanlar opsiyoneldir.



ACK 420S

ACK 420 S geniş ebatlı alüminyum ve PVC profilleri, düz veya dereceli olarak, Ø 420 mm testere ile kesmek amacı ile tasarlanmış kesme makinesidir.

- ▶ Çift el kumanda uygulaması
- ▶ 75°,60°,45°,30°,22.5°,15°,0° açılarda sağ ve sol yönde susta ile kesim
- ▶ -75° sol ve +75°sağ ara derecelerde hassas kesim
- ▶ Hidro-pnömatik kontrollü testere hareketi
- ▶ Daha yüksek kesim kapasitesi için hareketli gönye
- ▶ Ayarlanabilir testere çıkış hızı
- ▶ Manuel olarak açılan koruma kapağı
- ▶ Kabin içi LED aydınlatma



FR 226

3 mm kalınlığa kadar Alüminyum ve PVC kapı ve pencere profillerindeki, barel yuvası delikleri, su tahliye kanalları, menteşe ve ispanyolet yeri gibi birçok frezeleme ve delik delme işlemleri için kullanılır.

- ▶ Menteşe, üçlü kol yeri ve barel yuvası delikleri ile ispanyolet ve kilit yuvası açma gibi birçok frezeleme ve delik delme işlemleri için kullanılır
- ▶ Hidro-pnömatik Üçlü Kol Yeri delme
- ▶ Dökme alüminyum gövde
- ▶ Krom kaplı paslanmaz yataklama milleri
- ▶ Çelik sacdan üretilmiş makine sehpa sistemi
- ▶ Üçlü kol yeri için matkap uçları takılı olarak (2x Ø 10 1x Ø 13mm )
- ▶ Ø5 kesici takım monte edilmiş



ST 264

PVC profillere iki veya üç eksenle, değişik açılarda ve yüksekliklerde su tahliye kanalları açmak amacı ile kullanılan freze makinesidir.

- ▶ Su tahliye kanalı açma işlemi pnömatik olarak tamamlanır.
- ▶ 3 eksenle tek tek veya iki eksen de aynı anda su tahliye kanalı açılabilir.
- ▶ Dayamalar sayesinde su tahliye kanalı boyu ve derinliği pratik olarak ayarlanır.
- ▶ Hızı ayarlanabilir pnömatik kontrollü motor hareketi.
- ▶ 2 x pnömatik mngeneler profilin hassas olarak profilin sağlar.
- ▶ Tek butona basarak delme işlemi otomatik olarak başlatılır.
- ▶ Hareketli tabla ile profillerdeki eksen kaçıklıkları pnömatik olarak ayarlar.
- ▶ Butonlar ile motor seçimi.
- ▶ PLC kontrol sistemi.



TK 505

PVC profillerinin 30°-180° aralığında köşelerinin eritilerek birleştirilmeleri amacı ile kullanılır.

- ▶ 30°-180° açı aralığında tüm açılarda hassas kaynak yapabilmek.
- ▶ Standart (2 mm) veya sıfır (0.2 mm) kaynak kalınlığına manuel olarak geçiş özelliği.
- ▶ Çok yüksek profilleri (180 mm) kaynak yapabilmek özelliği.
- ▶ Eritme ve yapıştırma zamanı ile kaynak basıncı gibi tüm parametreler bağımsız olarak ayarlanabilmektedir.
- ▶ Kaynak işlemini otomatik olarak başlatma ve bitirme özelliği.
- ▶ Elektronik termostat sayesinde 0°- 300°C arasında ısıyı ayarlama özelliği.
- ▶ Plakaların temizlenmesi ve Teflon'un çok kolay ve hızlı değiştirilmesi nedeni ile kullanıcı dostudur.
- ▶ Her iki yönde yüksekliği ayarlanabilir profil destek kolları standart olarak verilmektedir.
- ▶ Ayak pedalı ile profilleri ayrı ayrı sabitleme özelliği
- ▶ Pratik kaynak kalıbı değiştirme sistemi ile zaman kaybı önlenir.



CK 412

PVC cam çita profillerinin 45° kesimi için ideal olup, otomatik olarak çalışan bir kesme makinesidir.

- ▶ Ayarlanabilir testere ilerleme hızı
- ▶ Tek bir butona basarak pnömatik testere hareketi başlar
- ▶ 2 x pnömatik dikey mngeneler
- ▶ İşlemin otomatik olarak başlangıç noktasına dönme özelliği
- ▶ Çift testere sistemi
- ▶ 8 ayrı çita profilini tek kalıpta kesme imkanı



SK450

SK 450 geniş ebatlı PVC ve alüminyum profilleri, seri olarak, Ø450 mm testere ile 90° kesmek amacı ile tasarlanmış, otomatik kesme makinesidir. Yüksek adetli hassas kesme operasyonları için idealdir.

- ▶ Yüksek adetli pencere ve endüstriyel profilleri dilimleme için uygundur.
- ▶ Yüksek performanslı servo motorlar ve dünyaca tanınan markalara ait malzeme kullanımı.
- ▶ Servo kontrollü profil ilerleme hızı ve testere strok kontrolü ile zaman tasarrufu sağlanır.
- ▶ Kesme sırasında otomatik olarak iş parçasını sabitleyen yatay ve dikey mengene sistemi.
- ▶ Testerenin aşağı hareketi sırasında profil yüzeyinde oluşabilecek çizilmeleri önlemek amacı ile profil tablası otomatik olarak geri çekilme hareketi yapar.
- ▶ Sağlam gövde sayesinde yüksek kesme hassasiyeti.
- ▶ Ekrandan miktarı ayarlanabilir testere soğutma sistemi
- ▶ Kesme program kayıt imkanı.
- ▶ Makine istenilen kesme adedine ulaştıktan sonra otomatik olarak durur
- ▶ Emniyet kilitli operatör koruma kapak sistemi.
- ▶ Tek seferde profil besleme stroğu (5 – 600 mm) Maksimumda sınır yoktur.
- ▶ Minimum kesme ölçüsü 5 mm. Maksimum ölçüde limit yoktur.
- ▶ Minimum ve maksimum Mengene kapasitesi: Yükseklik, 5 mm ,
- ▶ 170mm Genişlik 5 mm, 270 mm



DK502

PVC profillerinin iki köşesinin kaynak işlemi ile birleştirmeleri amacı ile kullanılır.

- ▶ PVC profillerin 90° de tam otomatik olarak kaynak işlemlerini yapar.
- ▶ 130°- 180° açı aralığında sol ünite üzerinde hassas kaynak ve temizlik özelliği.
- ▶ Eritme ve yapıştırma zamanı, kaynak basıncı gibi tüm parametreler bağımsız olarak kontrol paneli üzerinden ayarlanabilmektedir.
- ▶ Lineer yataklama mekanizması sayesinde hassas kaynak sağlanmaktadır.
- ▶ Tek operasyonda PVC kasa ve kanat profillerinin iki köşesini kaynatır.
- ▶ Teflon sarma sistemi ile pratik Teflon değiştirme özelliği ile kullanıcı dostudur.
- ▶ Pratik kaynak kalıbı değiştirme sistemi ile kayıp zaman kaybı önlenir.
- ▶ Profil çeşidine göre mengene ve yapıştırma basınç ayarı yapılabılır.
- ▶ Elektronik termostat sayesinde 0° – 300°C arasında ısıyı ayarlama özelliği.
- ▶ Standart (2 mm) veya sıfır (0.2 mm) kaynak kalınlığına göre pratik olarak operasyon yapabilmek özelliği.
- ▶ Sağ kafa manuel olarak hareket ettirilir ve sl kaynak ünitesi 90° sabit açıdır.
- ▶ Profiller sabitlendikten sonra kaynak işlemi otomatik olarak başlar.
- ▶ Hareketli sağ kaynak ünitesi üzerinde frenleme sistemi mevcuttur.
- ▶ Emniyet açısından mengene pistonları düşük basınç sistemi ile çalışmaktadır.
- ▶ 2 adet pencere destek profili mevcuttur.

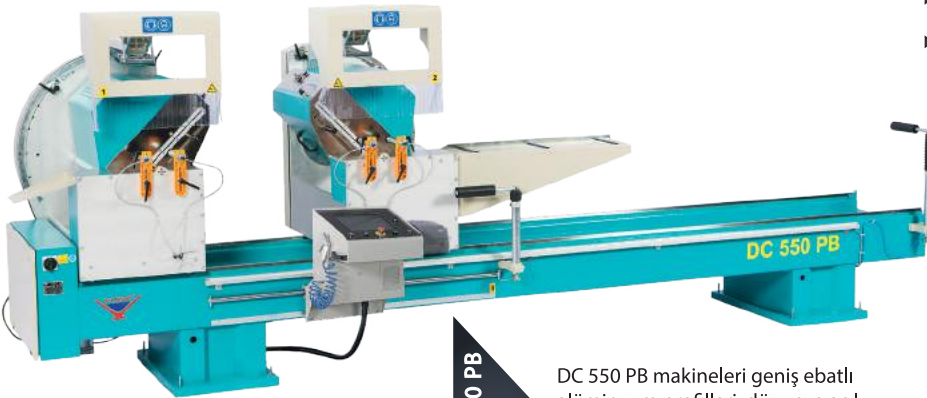

DC 550 PB

DC 550 PB makineleri geniş ebatlı alüminyum profilleri, düz veya açılı olarak, çift kafa Ø 550 mm testere ile kesmek amacı ile tasarlanmış tam otomatik kontrollü kesme makineleridir.

- ▶ Çift el çalıştırma güvenliği
- ▶ İçte 45° dışta 22,5° ara derecelerde manuel ayarlama
- ▶ İçte 45° dışta 22,5° aralığında bilgisayar kontrollü derece pozisyonlaması.
- ▶ Hidro- pnömatik kontrollü testere hareketi
- ▶ Kesme hassasiyeti +/- 0.1 mm,
- ▶ 2 x pnömatik profil desteği
- ▶ 90° ve 45° açılarda otomatik dilimleme
- ▶ Windows tabanlı endüstriyel PC ve 15" dokunmatik renkli panel ekran.
- ▶ USB bellek ve network üzerinden 'mdb' + 'xls' formatında kesim listesi transferi.
- ▶ Otomatik modda çalışırken profil ölçüleri ve açılarını kesim listesinden alır.
- ▶ Uzaktan bağlanma ve teknik destek sağlama
- ▶ Barkod yazıcı & resim baskı alma özelliği



# YEDEK PARÇALAR



► Ütü



► Ütü Teflonu



► Thermocouple



► Amortisör



► Piston



► Şartlandırıcı



► Şalter



► Şalter



► Şalter Kolu



► Yay

# KOMPRESÖRLER



MODEL	Engine			Compressor			Tank	Weight	Size/cm
	Hp	kW	Volt	rpm	Lt./dk.	Bar	TANK Lt.	AĞIRLIK Kg.	ÖLÇÜLER ExBxY
PE30/150-2	2	1,5	400	1220	250	9	100	65	55x125x80
PE30/150-2M	2	1,5	230	1220	250	9	100	68	55x125x80
PE30/200-3	3	2	400	1400	360	9	200	118	60x150x110
PE30/200-2M	3	2	230	1400	360	9	200	119	60x150x110
PE40/200-3	3	2	230	1400	360	9	200	119	60x150x110
PE40/300-4	4	3	400	1220	500	9	200	160	55x180x118
PE50/300-5,5	5,5	4	400	1140	690	9	300	162	55x180x118
PE50/500-5,5	5,5	4	400	1140	690	9	500	241	68x203x140
PE75/500-7,5	7,5	5,5	400	1060	910	9	500	300	68x203x140
PE100/500-10	10	7,5	400	980	1200	9	500	320	68x203x140
PE150/700-15	15	11	400	1000	1800	9	700	340	75x203x150

MODEL	Engine			Compressor			Tank	Weight	Size/cm
	Hp	kW	Volt	rpm	Lt./dk.	Bar	TANK Lt.	AĞIRLIK Kg.	ÖLÇÜLER ExBxY
PT36/200-3	3	2,2	400	830	375	12	200	125	60x150x110
PT40/300-4	4	3	400	910	375	12	300	160	55x180x118
PT50/300-5,5	5,5	4	400	830	550	12	300	162	55x180x118
PT50/500-5,5	5,5	4	400	900	600	12	500	251	68x203x140
PT50/500-7,5	7,5	5,5	400	1000	650	12	500	257	68x203x140
PT100/500-10	10	7,5	400	830	1000	12	500	300	68x203x140

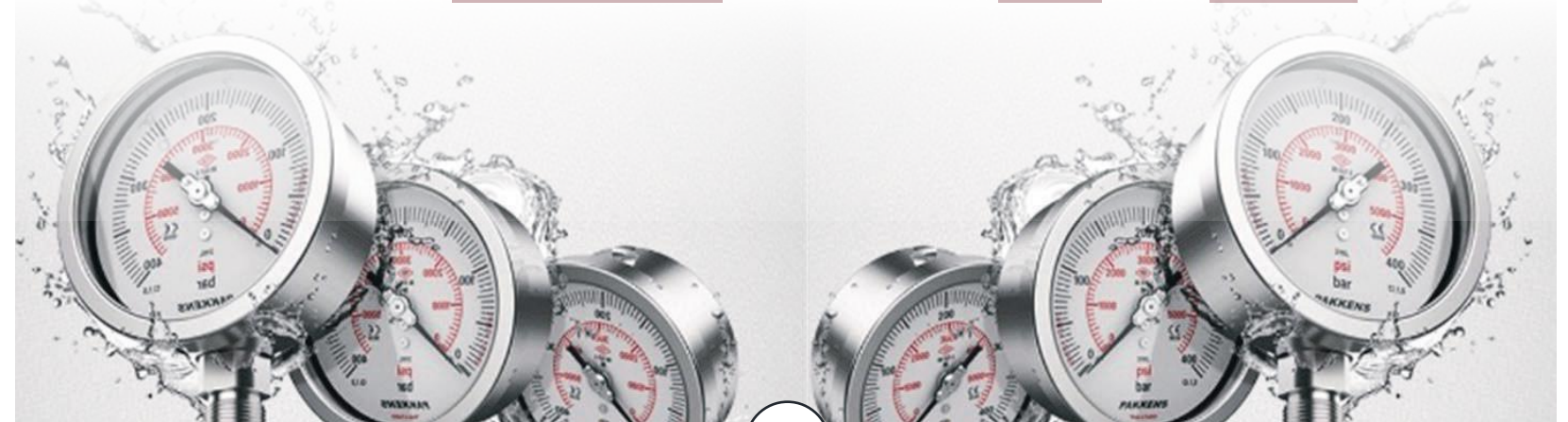

# ATÖLYE EKİPMANLARI

## DIŞ KÖŞE TEMİZLEME MAKİNESİ



## İÇ KÖŞE TEMİZLEME MAKİNESİ



## YÜZEY TEMİZLEME APARATI



## PROFİL BORU BÜKME MAKİNELERİ



## KOMPOZİT PANEL DERZ AÇMA MAKİNESİ



- ▶ Tetik kontrollü dalma sistemli kesme ve derz açma testeresi.
- ▶ Ray ve birleştirme aparatları aksesuar olarak harici satılmaktadır.

WB4000

## MONTAJ MASASI



- ▶ Pencere montajı ve genel çalışma amaçlı montaj tezgahıdır
- ▶ Yüksekliği ayarlanabilir ve zemine sabitlenebilir, kaymaz plastik ayaklar
- ▶ Montaj aksesuarları için avadanlıkların koyulacağı plaka
- ▶ Çalışma alanı, profil ebatlarına göre iki yönde ayarlama imkanı
- ▶ Çabuk takılan hava bağlantı kaplini mevcuttur
- ▶ Çalışma yüzeyi kauçuk malzeme ile kaplı olup, çalışılan profilin çizilmesini engeller
- ▶ 6 adet avadanlık ile beraber verilir
- ▶ Çalışma Tezgahı Genişliği: 2000 – 4000 mm
- ▶ Çalışma Tezgahı Derinliği: 1000 – 2000 mm
- ▶ Çalışma Yüksekliği : 820 mm
- ▶ Taşıma kapasitesi : 350 kg

GT1000

## CONTA TAŞIMA ARABASI



- ▶ 4 adet conta makarası bağlantı imkanı
- ▶ Farklı makara çaplarına uygun ayarlanabilir bölmeler
- ▶ Maksimum bağlanabilir makara sayısı: 4 ad. X Ø 550
- ▶ Maksimum makara genişliği: 300 mm
- ▶ 2'si frenli olmak üzere 4 adet tekerlek
- ▶ Yüksekli: 1500 mm
- ▶ Taşıma Kapasitesi :300 kg

# TESTERELLER

**SCHWERT**

**KÖNIG**

**freud.**

☎ 0 216 484 57 67

✉ info@akadmakine.com

🌐 www.akadmakine.com.tr

## ELMAS UÇLU ALUMİNYUM VE PVC KESME DAİRE TESTERELERİ

**ToolQuaz®**



KOD	D	S	s	d	z	FİYAT/€
YLMZ01	300	3,2	—	30	96	48,00 €
YLMZ02	350	3,4	—	30	108	71,00 €
YLMZ03	400	3,4	—	30	108	91,00 €
YLMZ04	420	4,0	—	30	108	123,00 €
YLMZ05	450	4,0	—	30	120	137,00 €
YLMZ06	550	4,4	—	30	120	228,00 €

Tüm testereleler demir dışı metaller ve plastik kesme işlemleri için uygundur.

**SCHWERT**



KOD	D	S	s	d	z	FİYAT/€
ALM20001	200	3,2	2,5	30	64N	52 €
ALM20002	200	2,0	1,8	30	64N	52 €
ALM23001	230	3,2	2,5	30	72N	55 €
ALM25001	250	3,2	2,5	30	80N	55 €
ALM30001	300	3,2	2,5	30	72N	65 €
ALM30003	300	2,4	1,8	30	96N	75 €
ALM30004	300	3,2	2,5	30-32	96N	69 €
ALM35001	350	3,6	2,8	30	72N	98 €
ALM35002	350	3,6	2,8	30	108N	108 €
ALM40001	400	3,6	2,8	30	108N	148 €
ALM40002	400	3,6	2,8	30-32	120N	155 €
ALM42001	420	4,0	3,2	30	96N	130 €
ALM42002	420	3,6	3,2	30-32	120N	165 €
ALM45001	450	4,0	3,2	30-32	108N	150 €
ALM45002	450	4,0	3,2	30-32	120N	175 €
ALM50001	500	4,0	3,2	30	108N	180 €
ALM50002	500	4,0	3,2	30	120N	200 €
ALM55001	550	4,0	3,2	30	108N	240 €
ALM55002	550	4,0	3,2	30	120N	255 €
ALM60001	600	4,0	3,2	30	120N	305 €

**freud.**



KOD	D	B	b	d	z	FİYAT
LU5D 0300	200	2,8	2,2	30	60	
LU5D 0400	210	2,8	2,2	30	60	
LU5D 0800	250	3,5	3,0	30	80	
LU5D 0900	250	3,5	3,0	32	80	
LU5D 1000	250	3,5	3,0	40	80	
LU5D 1100	275	3,5	3,0	40	84	
LU5D 1200	300	3,5	3,0	30	96	
LU5D 1300	300	3,5	3,0	32	96	
LU5D 1400	300	3,5	3,0	40	96	
LU5D 1700	350	3,5	3,0	30	108	
LU5D 1800	350	3,5	3,0	32	108	
LU5D 1900	350	3,5	3,0	40	108	
LU5D 2300	400	3,5	3,0	30	120	
LU5D 2400	400	3,5	3,0	32	120	
LU5D 2500	400	3,5	3,0	40	120	
LU5D 2600	400	3,5	3,0	50	120	
LU5D 2700	420	4,0	3,2	30	120	
LU5D 2800	420	4,0	3,2	40	120	
LU5D 2900	450	4,0	3,2	30	128	
LU5D 3400	500	4,0	3,2	32	140	

## ELMAS UÇLU ALÜMİNYUM VE PVC KESME DAİRE TESTERELERİ

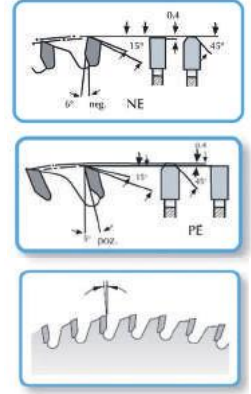

**Negatif dişli:** Değişik malzeme kalınlıkları olan sac Alüminyum Profil boru ve çubukların kesiminde özellikle kollar için uygundur.

**Pozitif dişli:** Malzeme kalınlığı 5 mm'den yukarı olan Alüminyum Profil borular ve çubukların kesiminde otomatik makinelerde tavsiye edilir.

Tüm testereler demir dışı metaller ve plastik kesme işlemleri için uygundur.

Kod	D	B	D	Z	€
ALM-115-01	115	4,0	22	48	34
ALM-140-01	140	2,4	30	48	38
ALM-160-01	160	2,2	30	58	39
ALM-170-01	170	3,0	30	58	40
ALM-180-01	180	3,0	30	58	41
ALM-180-02	180	3,0	30	58	50
ALM-190-01	190	2,0	30	58	50
ALM-190-02	190	3,0	30	40	50
ALM-200-01	200	3,0	30	64	43
ALM-200-02	200	3,0	30	64	52
ALM-200-03	200	3,0	30-32	64	54
ALM-210-01	210	2,0	30-32	64	56
ALM-210-02	210	2,0	30	36	56
ALM-230-01	230	3,0	30	72	40
ALM-230-02	230	3,0	30	30	57
ALM-235-03	235	3,2	30	60	42
ALM-250-01	250	3,0	30	80	53
ALM-250-02	250	3,2	30-32	80	55
ALM-250-03	250	3,2	30-32	48	59
ALM-270-01	270	2,0	30	88	51
ALM-270-02	270	3,0	30	88	70
ALM-275-01	280	2,4	30	48	51
ALM-280-01	280	2,5	30	64	57
ALM-280-02	300	3,2	30	88	72
ALM-300-01	300	3,2	30	48	51
ALM-300-02	300	3,2	30	60	57
ALM-300-03	300	3,2	30-32	72	63
ALM-300-04	300	3,2	30-32	96	67
ALM-300-05	300	2,0	30-32	96	72
ALM-305-01	305	3,2	30	96	72
ALM-320-01	320	3,2	32	96	87
ALM-330-01	330	3,6	32	108	91
ALM-350-01	350	3,6	30-32	84	84
ALM-350-02	350	3,6	30-32	96	88
ALM-350-03	350	3,6	30-32	108	94

Kod	D	B	D	Z	€
ALM-355-01	355	2,0	30	50	73
ALM-380-01	380	3,6	30	56	91
ALM-380-02	380	3,6	32	112	115
ALM-400-01	400	4,0	30	60	86
ALM-400-02	400	4,0	30	72	91
ALM-400-03	400	4,0	30-32	96	105
ALM-400-04	400	4,0	30-32	108	115
ALM-400-05	400	4,0	30-32	120	127
ALM-420-01	420	2,8	30	60	90
ALM-420-02	420	4,0	30	72	110
ALM-420-03	420	2,8	30	80	105
ALM-420-04	420	4,0	30-32	96	125
ALM-420-05	420	4,0	30-32	108	137
ALM-420-06	420	4,0	30-32	120	149
ALM-450-01	450	4,0	30	72	113
ALM-450-02	450	4,0	30	96	125
ALM-450-03	450	4,0	30-32	108	152
ALM-450-04	450	4,0	32	120	158
ALM-500-01	500	4,0	30	60	127
ALM-500-02	500	4,0	30	72	131
ALM-500-03	500	4,0	40	96	147
ALM-500-04	500	4,0	30	108	167
ALM-500-05	500	4,0	30-32	120	176
ALM-500-06	500	4,0	30	138	192
ALM-500-07	500	4,0	30	160	216
ALM-505-01	505	4,0	30	120	178
ALM-550-01	550	4,4	50	68	187
ALM-550-02	550	4,4	30	72	198
ALM-550-03	550	4,4	30	96	223
ALM-550-04	550	4,4	30-32	120	266
ALM-600-01	600	4,4	50	72	203
ALM-600-02	600	4,4	30	96	253
ALM-600-03	600	4,4	30	120	297
ALM-600-04	600	4,4	30	140	329
ALM-600-05	600	4,4	30	160	372

## PVC ÇİTA KESME TESTERELERİ VE 45° FREZE

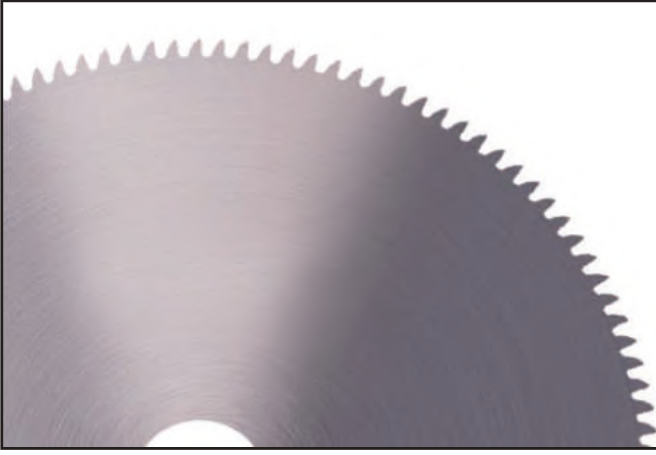

### PVC ÇİTA KESME TESTERELERİ

KOD	D	S	d	z	FİYAT/€
CK20001	200	1,8	32	160	30 €
CK20002	200	1,3	32	180	28 €
CK25001	250	2,0	32	100	32 €
CK25002	250	2,5	32	100	34 €
CK25003	250	1,3	32	230	32 €
CK30001	300	2,5	32	120	40 €
CK30002	300	1,3	32	280	42 €
CK35001	350	1,3	32	360	45 €
CK40001	400	1,3	40	410	60 €

### 45 DERECE FREZE

KOD	D	S	d	z	FİYAT/€
FR9501	95	1,8	32	80	35 €
FR9502	95	2,5	32	80	36 €
FR10001	100	3,0	32	80	37 €
FR10002	100	4,0	22	80	37 €
FR10003	100	4,0	32	80	37 €
FR10301	103	2,0	32	80	35 €
FR11001	110	4,0	20	80	37 €
FR11501	115	4,0	22	80	38 €
FR12001	120	4,0	22	80	38 €
FR12002	120	4,0	27	80	38 €
FR12501	125	4,0	22	80	38 €



KOD	D	S	d	z	FİYAT/€
KR8601	86	4,5	30	10	22 €
KR8701	87	4,5	30	10	22 €
KR12001	120	6,0	30	14	28 €
KR12701	127	4,5	30	12	26 €
KR12801	128	4,5	30	12	26 €
KR16101	161	6,0	30	16	42 €

Tüm testereler Alüminyum, PVC profil orta kayıt alıştırma işlemleri için uygundur.

Talep edilmesi durumunda özel profil tiplerine göre uygun bıçaklar üretilir.

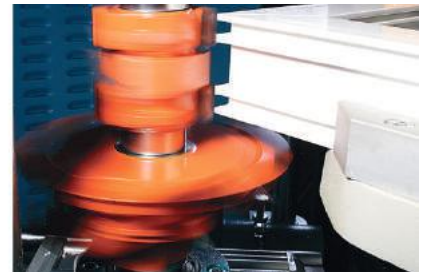

## ELMAS UÇLU ALUCOBOND TESTERELER

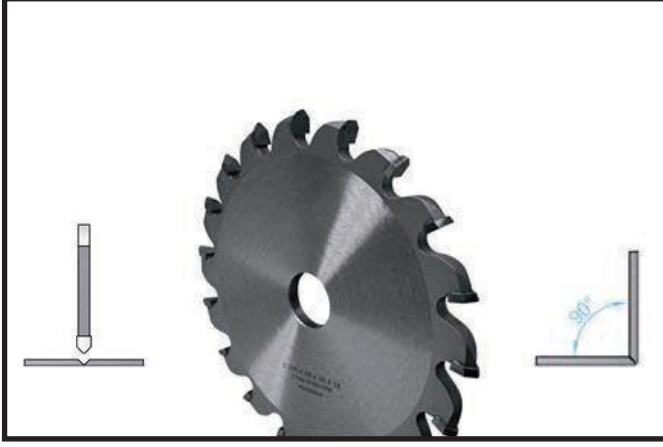

KOD	D	S	d	z	FİYAT/€
AC15001	150	8,0	30	18	77 €
AC15002	150	10,0	30	18	82 €
AC18001	180	8,0	30	18	80 €
AC18002	180	8,5	30	18	83 €
AC18003	180	10,0	30	18	87 €
AC18004	180	8,0	30	24	90 €
AC18005	180	10,0	30	24	95 €
AC20001	200	8,0	30	18	94 €
AC20002	200	8,5	30	18	98 €
AC20003	200	10,0	30	18	105 €
AC20004	200	8,0	30	24	100 €
AC20005	200	10,0	30	24	110 €

## METAL PROFİL KESME TESTERELERİ

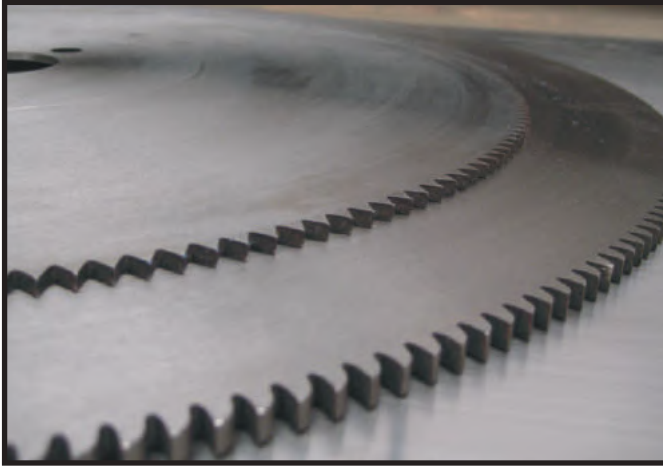

KOD	D	S	d	z	FİYAT/€
MKP20001	200	2,0	32	124	20 €
MKP25001	250	2,5	32	156	25 €
MKP30001	300	2,5	32	186	27 €
MKP35001	350	2,5	32	216	39 €
MKP40001	400	3,0	40	230	52 €
MKP40002	400	4,0	40	230	56 €
MKP45001	450	3,0	40	260	58 €
MKP45002	450	4,0	40	260	61 €
MKP52001	520	3,0	40	300	59 €
MKP52002	520	4,0	40	300	65 €

Testere demir profil kesme işlemlerine uygundur.

## PROFİL VE DOLU MALZEME KESİM TESTERELERİ

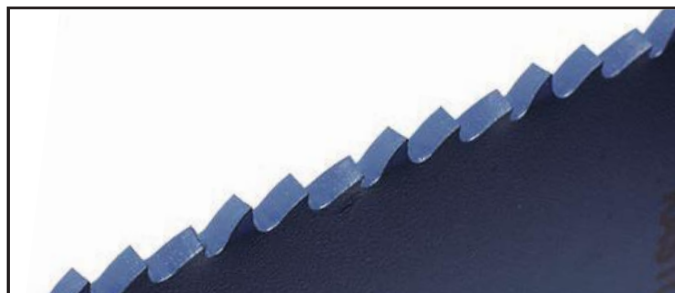

KOD	D	S	d	Z	FİYAT
HSS20001	200	1,6- 1,8	32	--	57 €
HSS22501	225	1,8	32	--	60 €
HSS23501	235	1,9	32	--	55 €
HSS25001	250	1,6	32	--	65 €
HSS25002	250	2,0	32	--	64 €
HSS27501	275	1,6	32	--	86 €
HSS27502	275	2,0	32	--	84 €
HSS27503	275	2,5	32-40	--	85 €
HSS30001	300	2,0	32-40	--	105 €
HSS30002	300	2,5	32	--	106 €
HSS31501	315	2,0	32	--	107 €
HSS31502	315	2,5	32-40	--	111 €
HSS35001	350	2,0	32	--	144 €
HSS35002	350	2,5	32-40	--	141 €
HSS37001	370	3,0	32	--	205 €
HSS40001	400	3,0	32-40-50	--	215 €
HSS45001	450	3,0	40-50	--	290 €

Tüm testere için diş sayısı 80- 90-100- 110- 120- 128  
-140- 160-180- 200- 220- 240- 260- 280-300-310-320



## ELMAS UÇLU TRAPEZ TESTERELER

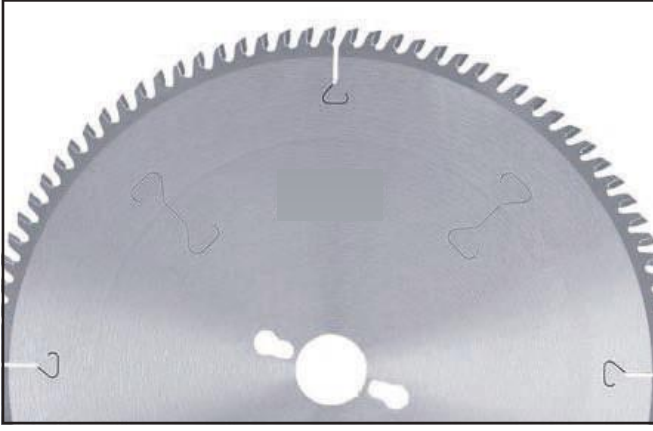

Tüm testere MDF, MDF lam, laminant, kaplamalı sunta ve kesim işlemlerinde kullanılır.

KOD	D	S	s	d	z	FİYAT/€
TRP20001	200	3,2	2,2	30	64 TRP	52 €
TRP25001	250	3,2	2,2	30	80 TRP	55 €
TRP30001	300	3,2	2,2	30	72 TRP	60 €
TRP30002	300	3,2	2,2	30	96TRP HP+ 15°	69 €
TRP35001	350	3,6	2,5	30	108 TRP	95 €
TRP40001	400	4,0	3,2	30	120 TRP	115 €
TRP45001	450	4,0	3,2	30	120 TRP	145 €

## ELMAS UÇLU AHŞAP TESTERELER

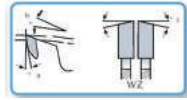
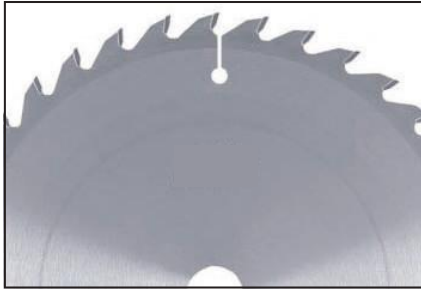

Tüm testere sert ve yumuşak masif, sunta, MDF, kaplamalı MDF ve kaplamalı sunta ürünlerin kesme işlemlerinde kullanılır.

KOD	D	S	s	d	z	FİYAT/€
WC25001	250	2,2	1,6	30	24 LWZ	32 €
WC25002	250	3,2	2,2	30	24 LWZ	32 €
WC25003	250	3,2	2,2	30	48 WZ	43 €
WC25004	250	3,2	2,2	30	60WZ	48 €
WC25005	250	3,2	2,2	30	80 WZ	55 €
WC30001	300	3,2	2,2	30	26 LWZ	37 €
WC30002	300	2,7	1,6	30	26 LWZ	47 €
WC30003	300	3,2	2,2	30	48 WZ	52 €
WC30004	300	3,2	2,2	30	60 WZ	56 €
WC30005	300	3,2	2,2	30	72 WZ	60 €
WC30006	300	3,2	2,2	30	96 WZ	65 €
WC35001	350	3,6	2,5	30	32 LWZ	70 €
WC35002	350	3,6	2,5	30	40 LWZ	80 €
WC35003	350	3,6	2,5	30	72 WZ	90 €
WC35004	350	3,6	2,5	30	108 LWZ	95 €
WC40001	400	3,6	2,5	30	36 LWZ	90 €
WC40002	400	3,6	2,5	30	64 WZ	92 €
WC45001	450	4,0	2,8	30	56 WZ	95 €
WC50001	500	4,0	2,8	30	44 LWZ	110 €
WC50002	500	4,0	2,8	30	64 WZ	120 €
WC55001	550	4,2	2,8	30	48 LWZ	120 €

## ELMAS UÇLU ÇİZİCİ TESTERELER



Tüm testere Suntalam, MDFlam, laminant ve kaplamalı plakaların alt yüzeyde ön çizimini yaparak kırılmayı önler.

KOD	D	S	d	z	FİYAT/€
CZC001	125	2,8 - 3,6	20	12+12 FZ-S	75 €
CZC002	125	2,8 - 4,0	20	24 KON	46 €

## Bİ METAL M42 ŞERİT TESTERE

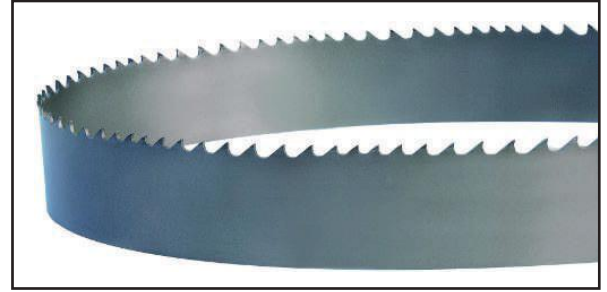

İstenilen ölçüde kaynaklı teslim edilebilir.

ŞERİT EBADI ( mm )	TPI - DIŞ SAYISI
6x0,90	6-8-10-14-10/14
10x0,90	6-8-10-14-10/14
13x0,65	6-8-10-14-8/12-10/14
13x0,90	6-8-10-14-8/12-10/14
20x0,90	4-6-8-10-14-6/10-8/12-10/14
27x0,90	3-4-6-8-14- 2/3/4/6/5/8-6/10-10/14
34x1,10	3-4-6-2/3-3/4-4/6



# KESİCİ TAKIMLAR



Elmer®  
Made in Germany

dress®  
Made in Germany

☎ 0 216 484 57 67

✉ info@akadmakine.com

🌐 www.akadmakine.com.tr

# FREZELER

Tüm freze uçları kopya freze makinalarına uyumlu ve Alüminyum , PVC profil işleme amaçlı kullanılır.

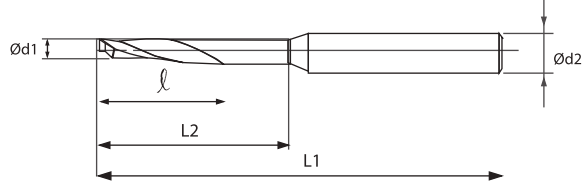

**Elmer®**  
Made in Germany



Tip 1 / type 1					
KOD	d1	l	L1	d2	FİYAT
100312608	3	12	60	8	-----
100412608	4	12	60	8	-----
100414606	4	14	60	6	-----
1004201208	4	20	120	8	-----
100512606	5	12	60	6	-----
100512608	5	12	60	8	-----
100518608	5	18	60	8	-----
100525708	5	25	70	8	-----
1005251008	5	25	100	8	-----
1005401008	5	40	100	8	-----
1005141208	5	14	120	8	-----
100614608	6	14	60	8	-----
100616608	6	16	60	8	-----
100716608	7	16	60	8	-----

Tip 2 / type 2							
KOD	d1	l	L1	L2	d2	FİYAT	
241645908	4	16	45	90	8	-----	
251835806	5	18	35	80	6	-----	
251835808	5	18	35	80	8	-----	
251645908	5	16	45	90	8	-----	
2518351008	5	18	35	100	8	-----	
2525551008	5	25	55	100	8	-----	
2514751208	5	14	75	120	8	-----	
2518351208	5	18	35	120	8	-----	
261435808	6	14	35	80	8	-----	
2618351008	6	18	35	100	8	-----	
281454808	8	14	54	80	8	-----	
2830701008	8	30	70	100	8	-----	
2814901208	8	14	90	120	8	-----	
210307010010	10	30	70	100	10	-----	
210149512010	10	14	95	120	10	-----	

Tip 3 / type 3					
KOD	d1	l	L1	d2	FİYAT
300614606	6	14	60	6	-----
300816808	8	16	80	8	-----
3008141008	8	14	100	8	-----
3008141208	8	14	120	8	-----
3008281208	8	28	120	8	-----
300914808	9	14	80	8	-----
3001014808	10	14	80	8	-----
300101412010	10	14	120	10	-----
3001214808	12	14	80	8	-----

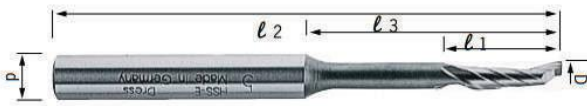

KOD	D	d	L1/L3	L2	FİYAT
DR0501	5	6	12/-	60	-----
DR0502	5	8	12/-	60	-----
DR0503	5	6	12/-	80	-----
DR0504	5	8	14/-	120	-----
DR0505	5	8	40/-	100	-----
DR0601	6	8	14/-	60	-----
DR0801	8	8	14/-	80	-----
DR0802	8	8	14/-	120	-----
DR0803	8	8	25/-	80	-----
DR1001	10	10	14/-	120	-----
DR0521	5	8	18/35	80	-----
DR0522	5	8	18/35	100	-----
DR0821	5	8	14/68	100	-----



## FREZELER



KOD	ÖLÇÜ	KUTU	FİYAT
2400	5X8X80	40	-----
2410	5X6X80	40	-----
2420	5X8X60	40	-----
2425	5X8X100	50	-----
2430	5X8X120	10	-----
2440	5X6X120	10	-----
2450	8X8X120	10	-----
2460	5X8X80	HSS-E COBALT /40	-----
2465	4X8X80	40	-----
2470	6X8X80	40	-----

Sipariş üzerine 135° elmas uçlu freze uçları temin edilebilir.

KOD	d1 (mm)	L1 (mm)	d2 (mm)	FİYAT/€
ALUC001	18	50	8	

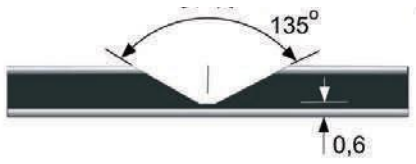

90°

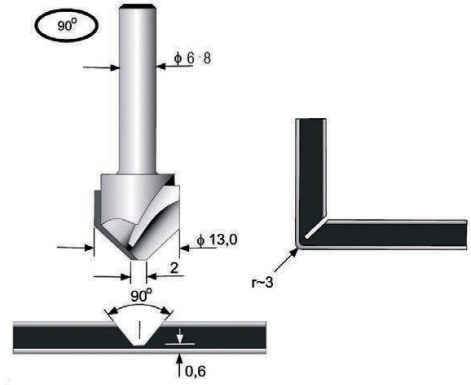

### Kompozit Panel Kesme Freze Uçları



### Kompozit Panel Derz Açma Freze Uçları



- Özel ölçü talepleriniz için lütfen iletişime geçiniz.

# ÜÇLÜ KOL YERİ DELME UÇ TAKIMLARI



YILMAZ MAKİNE / Veldon

6 X 11 X 107 mm

6 X 11 X 107 mm

6 X 13 X 110 mm Veldon

ÜRÜN KODU: M41



KABAN MAKİNE / Eski

5,5 X 11 X 107 mm

5,5 X 11 X 110 mm

5,5 X 13 X 115 mm Veldon

ÜRÜN KODU: M17



ELUMATEC / Metrik 10 Vidalı

6 X 10 X 90 mm

6 X 10 X 90 mm

6 X 12 X 86,5 mm

ÜRÜN KODU: M13



ELUMATEC / Metrik 10 Vidalı

5 X 10 X 115 mm

5 X 10 X 115 mm

5 X 12 X 115 mm

ÜRÜN KODU: M14



ETM

5 X 10 X 127mm

5 X 10 X 127 mm

6 X 12 X 125 mm Veldon

ÜRÜN KODU: M15



HEGSAN

5 X 10 X 115 mm

5 X 10 X 115 mm

6 X 13 X 120 mm Veldon

ÜRÜN KODU: M16



OMURZAK MAKİNE / Metrik 8 Vidalı

5 X 12 X 125 mm

5 X 12 X 125 mm

6 X 13 X 130 mm

ÜRÜN KODU: M23



ÖZÇELİK MAKİNE

5 X 10 X 100 mm

5 X 10 X 100 mm

6 X 12 X 84 mm

ÜRÜN KODU: M25



YILMAZ MAKİNE / Metrik 8 Vidalı

6 X 10 X 117 mm

6 X 10 X 117 mm

6 X 13 X 120 mm Veldon

ÜRÜN KODU: M42



KABAN MAKİNE / Metrik 8 Vidalı

5,5 X 11 X 110 mm

5,5 X 11 X 110 mm

5,5 X 13 X 115 mm Veldon

ÜRÜN KODU: M18



KABAN MAKİNE / Yeni

5,5 X 11 X 86 mm

5,5 X 11 X 86 mm

5,5 X 13 X 89 mm Veldon

ÜRÜN KODU: M19



MURAT MAKİNE / VELDON

5 X 11 X 90 mm

5 X 11 X 95 mm

5 X 12 X 100 mm Veldon

ÜRÜN KODU: M20



MURAT MAKİNE / Vidalı

5 X 11 X 100 mm

5 X 11 X 100 mm

5 X 12 X 100 mm Vidalı

ÜRÜN KODU: M21



NİKMAK MAKİNE

6 X 10 X 107 mm

6 X 10 X 107 mm

6 X 13 X 110 mm Veldon

ÜRÜN KODU: M22



OMURZAK MAKİNE / Metrik 10 Vidalı

5 X 10 X 125 mm

5 X 10 X 125 mm

6 X 12 X 130 mm

ÜRÜN KODU: M24



ÖZGENÇ MAKİNE / Veldon

5,5 X 11 X 115 mm

5,5 X 11 X 115 mm

5,5 X 12 X 120 mm Veldon

ÜRÜN KODU: M26

## ÜÇLÜ KOL YERİ DELME UÇ TAKIMLARI

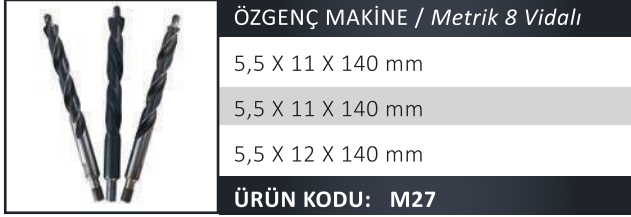

ÖZGENÇ MAKİNE / Metrik 8 Vidalı

5,5 X 11 X 140 mm

5,5 X 11 X 140 mm

5,5 X 12 X 140 mm

ÜRÜN KODU: M27

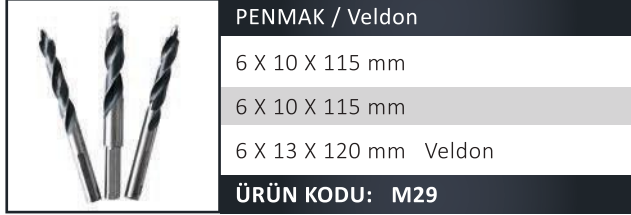

PENMAK / Veldon

6 X 10 X 115 mm

6 X 10 X 115 mm

6 X 13 X 120 mm Veldon

ÜRÜN KODU: M29



RISUS (DAIZER) MAKİNE

5 X 10 X 120 mm

5 X 10 X 120 mm

5,5 X 12 X 125 mm

ÜRÜN KODU: M31



SAWIN / Veldon

5 X 10 X 140 mm Sağ

5 X 10 X 140 mm Sağ

5 X 12 X 145 mm Sol

ÜRÜN KODU: M33

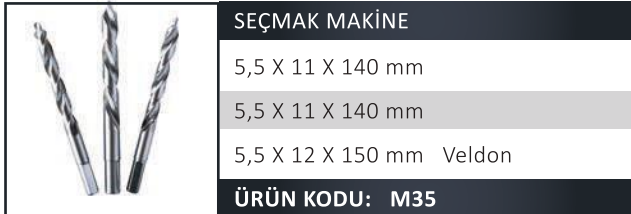

SEÇMAK MAKİNE

5,5 X 11 X 140 mm

5,5 X 11 X 140 mm

5,5 X 12 X 150 mm Veldon

ÜRÜN KODU: M35

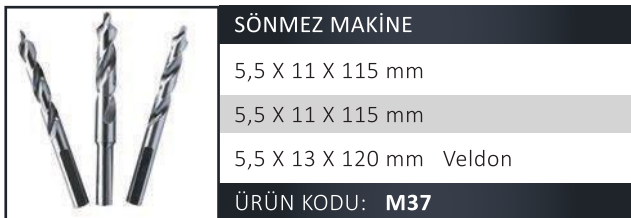

SÖNMEZ MAKİNE

5,5 X 11 X 115 mm

5,5 X 11 X 115 mm

5,5 X 13 X 120 mm Veldon

ÜRÜN KODU: M37



TAHA BAYRAK / Metrik 10 Vidalı

6 X 11 X 140 mm

6 X 11 X 140 mm

6 X 13 X 150 mm

ÜRÜN KODU: M39



ARTİKON - SETİNO MAKİNE / Eski

5 X 10 X 90 mm

5 X 10 X 95 mm

5 X 12 X 100 mm Veldon

ÜRÜN KODU: M11

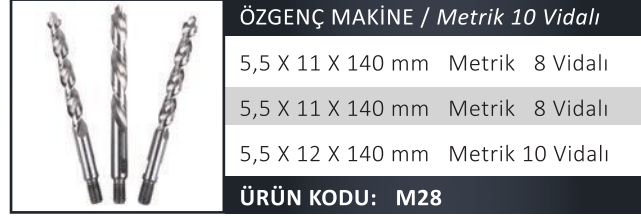

ÖZGENÇ MAKİNE / Metrik 10 Vidalı

5,5 X 11 X 140 mm Metrik 8 Vidalı

5,5 X 11 X 140 mm Metrik 8 Vidalı

5,5 X 12 X 140 mm Metrik 10 Vidalı

ÜRÜN KODU: M28



PENMAK / Metrik 10 Vidalı

6 X 13 X 100 mm

6 X 13 X 100 mm

6 X 13 X 130 mm Veldon

ÜRÜN KODU: M30

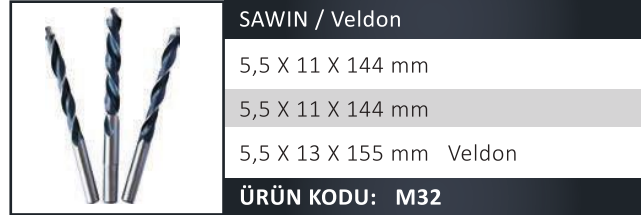

SAWIN / Veldon

5,5 X 11 X 144 mm

5,5 X 11 X 144 mm

5,5 X 13 X 155 mm Veldon

ÜRÜN KODU: M32



SAWIN / Veldon

5 X 10 X 140 mm Sağ

5 X 10 X 140 mm Sağ

5 X 12 X 145 mm Sağ

ÜRÜN KODU: M34



SELİM AYKIRCA (BRÖGEN) MAKİNE

6 X 11 X 140 mm

6 X 11 X 140 mm

6 X 13 X 150 mm Veldon

ÜRÜN KODU: M36

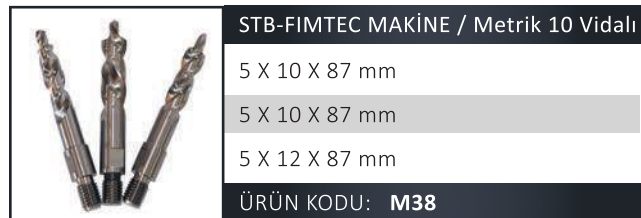

STB-FIMTEC MAKİNE / Metrik 10 Vidalı

5 X 10 X 87 mm

5 X 10 X 87 mm

5 X 12 X 87 mm

ÜRÜN KODU: M38

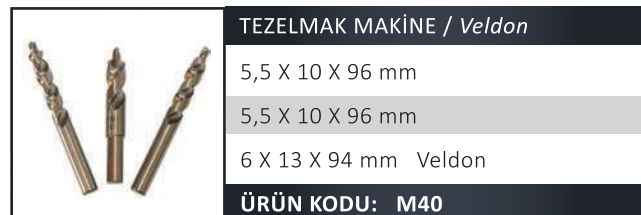

TEZELMAK MAKİNE / Veldon

5,5 X 10 X 96 mm

5,5 X 10 X 96 mm

6 X 13 X 94 mm Veldon

ÜRÜN KODU: M40



ARTİKON - SETİNO MAKİNE / Yeni

5 X 11 X 100 mm

5 X 11 X 105 mm

5 X 12 X 110 mm Veldon

ÜRÜN KODU: M12

## PVC YÜZEY VE İÇ KAZIMA BIÇAKLARI



BEYAZ BIÇAK

MODEL FD145



RENKLİ BIÇAK

MODEL FD146



İÇ KAZIMA BIÇAK

DEL FD1



BEYAZ BIÇAK

MODEL FD148



RENKLİ BIÇAK

MODEL 100

*elumatec*



BEYAZ BIÇAK (ESKİ)

MODEL FD149



BEYAZ BOMBELİ BIÇAK

MODEL FD150



İÇ KAZIMA BIÇAĞI

MODEL FD151



BEYAZ BIÇAK (TEK AĞIZ)

MODEL FD152



BEYAZ BIÇAK (ESKİ)

MODEL FD153

*elumatec*



BEYAZ BIÇAK

MODEL FD154



BEYAZ BIÇAK

MODEL FD155



RENKLİ BIÇAK

MODEL FD156



DİK AÇI BIÇAK

MODEL FD157



GENİŞ AÇI BIÇAK

MODEL FD158

*ARTIKON*



BEYAZ BIÇAK

MODEL FD166



BEYAZ BIÇAK

MODEL FD167



RENKLİ BIÇAK

MODEL FD168

**PENMAK**



BEYAZ BIÇAK

MODEL FD163

**NIKMAK**



BEYAZ BIÇAK

MODEL FD164

## PVC YÜZEY VE İÇ KAZIMA BIÇAKLARI

**murat**



BEYAZ BIÇAK

MODEL FD130



RENKLİ BIÇAK

MODEL FD131



BEYAZ BIÇAK

MODEL FD132



RENKLİ BIÇAK

MODEL FD133



BEYAZ BIÇAK (ESKİ)

MODEL FD134

**murat**



BEYAZ BOMBELİ BIÇAK

MODEL FD135



İÇ KAZIMA BIÇAĞI

MODEL FD136



BEYAZ BIÇAK (TEK AĞIZ)

MODEL FD137

**KABAN**



BEYAZ BIÇAK (ESKİ)

MODEL FD138



BEYAZ BIÇAK

MODEL FD139



BEYAZ BIÇAK

MODEL FD140

**KABAN**



RENKLİ BIÇAK

MODEL FD141



DİK AÇI BIÇAK

MODEL FD142



GENİŞ AÇI BIÇAK

MODEL FD143



RENKLİ BIÇAK (BÜYÜK)

MODEL FD144

**titiz**



RENKLİ BIÇAK

MODEL FD165

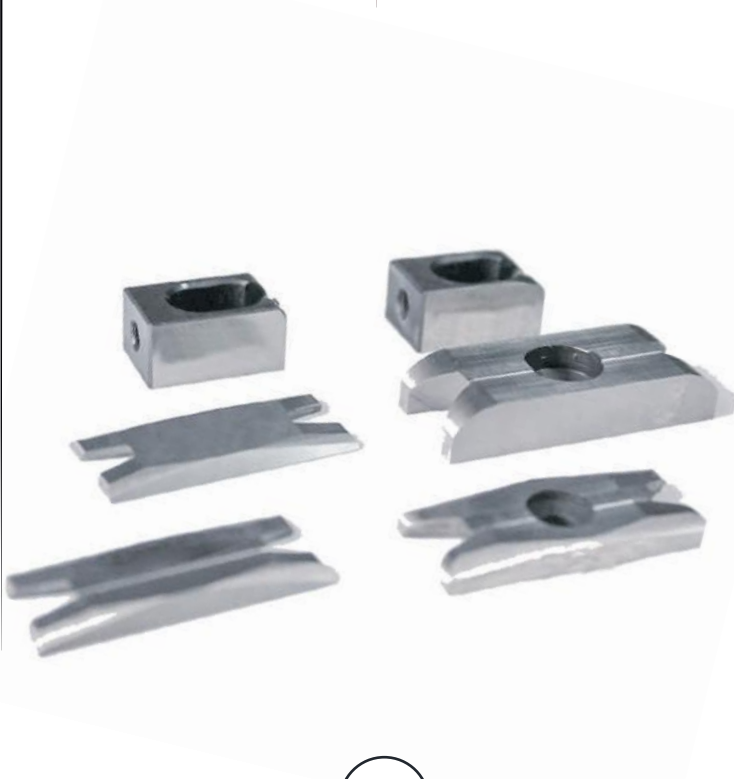



# ELEKTRIKLİ & HAVALI EL ALETLERİ



0 216 484 57 67



info@akadmakine.com



www.akadmakine.com.tr

## ELEKTRİKLİ EL ALETLERİ



ÖZELLİKLER	KLNM 1020	KLNM 1420	KLNM 1820
Akü	10.8 V / 2.0Ah Li-on	14.4 V / 2.0Ah Li-on	18 V / 2.0Ah Li-on
Çift Akü	✓	✓	✓
Elektronik Sağ / Sol	✓ / ✓	✓ / ✓	✓ / ✓
Koli Adedi	2	2	2
Maksimum Tork	22Nm	27Nm	27Nm
Mandren Kapasitesi	0.8-10mm	2-13mm	2-13mm
Taşıma Çantası	✓	✓	✓
Tork Ayarı	19 + 1	19 + 1	19 + 1
Yüksüz Hızı	0 - 350 / 0-1300 dev/dk	0 - 350 / 0-1200 dev/dk	0 - 350 / 0-1200 dev/dk



ÖZELLİKLER	KLNM 61210	KLNM 1002	KLDM 1305
Elektronik Sağ / Sol	✓ / ✓	✓ / ✓	✓ / ✓
Gücü	500 W	600 W	800 W
Koli Adedi	10	10	8
Mandren Kapasitesi	10 mm	10 mm	13 mm
Yüksüz Hızı	0 - 3500 dev/dk	0 - 3500 dev/dk	0 - 2800 dev/dk



ÖZELLİKLER	KLAT 11505	KLBT 87180	KLBT 87230
Ağırlık	2 Kg	X	X
Disk Çapı	115 mm	180 mm	230 mm
Gücü	850 W	2600 W	2600 W
Koli Adedi	10	4	4
Yüksüz Hızı	1100 dev / dk	8000 dev / dk	6500 dev / dk
Yumuşak Başlangıç	X	✓	✓

## ELEKTRİKLİ EL ALETLERİ



ÖZELLİKLER	KLPM 2601
Betonda Delme Kapasitesi	26 mm
Darbe Gücü	3.2 J
Darbe Oranı	0 - 4200 dar. / dk
Elektronik / Sağ - Sol	✓ / ✓
Gücü	850 W
Koli Adedi	4
Yüksüz Hızı	0 - 1100 dev/dk



ÖZELLİKLER	KLKT 505
Ağırlık	1.4 Kg
Boy	Kısa
Elektronik / Mil Kilidi	X / ✓
Gücü	450 W
Koli Adedi	10
Maksimum Pens Çapı	6 mm
Yüksüz Hızı	27000 dev/dk



ÖZELLİKLER	KLPK 1306
Ağırlık	20 Kg
Disk Çapı	355 X 25.4 mm
Gücü	2400 W
Koli Adedi	1
Mil Kilidi	✓
Yüksüz Hızı	3800 dev/dk
Yumuşak Başlangıç	X



ÖZELLİKLER	KLLZM 50
Koli Adedi	10
Lazer Sınıfı	635nm Class II
Ölçme Hassasiyeti	+ 2 mm
Ölçme Mesafesi	50 m
Pil	2 X 1.5 V AAA



ÖZELLİKLER	KLMMA 200
Ağırlık	5.9 Kg
Akım Aralığı	25 - 200A
Çektiği Güç	8.0 kVA
Elektro Çapı	1.6 - 5.0 mm
Frekans	50 / 60 Hz
Giriş Voltajı	230 V
İzolasyon Sınıfı	H
Koli Adedi	1
Koruma Sınıfı	IP 21 S



ÖZELLİKLER	KLLZR 118
Hizalama Hassaslığı	± 0.3 mm / m
İç Mekanda Görünürlük	15 M
Işın Sayısı	2
Işın Yönü	Dikey / Yatay
Koli Adedi	5
Lazer Sınıfı	2<1 mW
Lazer Tipi	Yeşil

**KL PRO**

Gücün Ustası, Ustanın Gücü

## ELEKTRİKLİ EL ALETLERİ

**DEWALT**



Akülü Vidalamalar



Matkaplar



Taşlamalar



Pnömatik Matkaplar  
(SDS - PLUS)

**Makita**



Akülü Vidalamalar



Matkaplar



Taşlamalar



Pnömatik Matkaplar  
(SDS - PLUS)

**Einhell**



Akülü Vidalamalar



Matkaplar



Taşlamalar



Pnömatik Matkaplar  
(SDS - PLUS)

Diğer ürün çeşitleri ve detaylı bilgi için iletişime geçiniz.

## HAVALI EL ALETLERİ

OSAKA

Sappower  
pneumatic tools



Diğer ürün çeşitleri ve detaylı bilgi için iletişime geçiniz.

ÖZELLİKLER	10 MM MATKAP SAĞ-SOL	10 MM MATKAP SAĞ-SOL
UZUNLUK	185 mm	176 mm
MANDREN KAP	10 mm	10 mm
MANDREN BA	3/8 24 UNF	3/8 24 UNF
BOŞTA DEVİR	1.800 rpm	1.500 rpm
SES ŞİDDETİ	83 dB (A)	83 dB (A)
HORTUM ÇAPI	10 mm	10 mm
HAVA GİRİŞ NİPELİ	1/4"	1/4"
HAVA TÜKETİMİ	113 lt/dk	150 lt/dk
ÇALIŞMA BASINCI	90-115 psi (6.2-8 atü)	90-115 psi (6.2-8 atü)
AĞIRLIK	1.10 kg	1.39 kg

ÖZELLİKLER	6 MM TORNAVİDA	8 MM TORNAVİDA
UZUNLUK	196 mm	216 mm
VİDA ÇAPI	6 mm	8.00 mm
SOKET KARESİ	1/4"	1/4"
MAX. TORK	13 Nm	16 Nm
BOŞTA DEVİR	1.800 rpm	800 rpm
HORTUM ÇAPI	10 mm	9.5 mm
HAVA GİRİŞ NİPELİ	1/4"	1/4"
HAVA TÜKETİMİ	174 lt/dk	170 lt/dk
ÇALIŞMA BASINCI	90-115 psi (6.2-8 atü)	90 psi (6.2 atü)
AĞIRLIK	1.10 kg	1.30 kg

### KLCT622P



#### HAVALI ÇİVİ ÇAKMA MAKİNESİ

Ağırlık : 0.7kg

Çivi Çapı : 0.63 mm

Çivi Tipi : Başsız

Çivi Çapı : 0.63 mm

Çivi Uzunluğu : 12 - 22 mm

Kartuş Kapasitesi : 100 Çivi

Koli Adedi : 10

Taşıma Çantası : Var

### KLZCT509040



#### HAVALI ÇİVİ / ZIMBA ÇAKMA MAKİNESİ

Ağırlık : 1.6 kg

Çivi / Zimba Uzunluğu : 20-50 / 16-40 mm

Çivi / Zimba Genişliği : 1.25 / 5.7 mm

Çivi Tipi : Kesik Başlı

Kartuş Kapasitesi : 100 Çivi / 100 Zimba

Koli Adedi : 5

Taşıma Çantası : Var

### KLZT8016H



#### HAVALI ZIMBA ÇAKMA MAKİNESİ

Ağırlık : 0.9kg

Zimba Genişliği : 12.8 mm

Zimba Uzunluğu : 6-16 mm

Kartuş Kapasitesi : 120 Zimba

Koli Adedi : 10

Taşıma Çantası : Var

### SPİRAL HAVA HORTUMU



5X8 mm

6,5X10 mm

Uzunluk : 15 mt

Uzunluk : 15 mt

Koli Adedi : 30

Koli Adedi : 20

### RULO HAVA HORTUMU



5X8 mm

6,5X10 mm

Uzunluk : 100 mt

Uzunluk : 100 mt

Mavi , Turuncu

Mavi , Turuncu

8x12 mm

Uzunluk : 100 mt

Mavi , Turuncu

### PNÖMATİK BAĞLANTI ELEMANLARI



### MAKARALI HAVA HORTUMU



# HIRDAVAT ÜRÜNLERİ

0 216 484 57 67  
info@akadmakine.com  
www.akadmakine.com.tr

## HIRDAVAT ÜRÜNLERİ



AKD100

TEKLİ VANTUZ



AKD101

2'Lİ VANTUZ



AKD102

3'LÜ VANTUZ



AKD103

METAL GAZLI  
CAM ELMASI



AKD104

PLASTİK GAZLI  
CAM ELMASI



AKD105

AHŞAP  
CAM ELMASI



AKD106

CAM PENSESİ



AKD107

T KESER



AKD108

CAM PERGELİ



AKD109

T KESER YEDEK UCU



AKD110

T KESER YEDEK KAFA



AKD111

CAM GÖNYE



AKD112

PANJUR KORDONU



AKD113

CAM KÜREĞİ



Diğer ürün çeşitleri ve detaylı bilgi için iletişime geçiniz.

## HIRDAVAT ÜRÜNLERİ



AKD200

PLASTİK SİLİKON  
TABANCASI



AKD201

İSKELET SİLİKON  
TABANCASI



AKD202

STANDART METAL  
SİLİKON TABANCASI



AKD203

KANCALI METAL  
SİLİKON TABANCASI



AKD204

SOSİS  
TABANCASI



AKD205

EPOKSİ  
TABANCASI



AKD206

TEFLON KÖPÜK  
TABANCASI



AKD207

PROF. KÖPÜK  
TABANCASI



AKD208

HAVA TABANCASI  
(Kısa)



AKD209

HAVA TABANCASI  
(Uzun)



AKD210

BOYA  
TABANCASI



AKD211

PERÇİN  
TABANCASI



## HIRDAVAT ÜRÜNLERİ



AKD300

AĞAÇ SAPLI  
LASTİK TOKMAK



AKD301

AĞAÇ TOKMAK



AKD302

ÇELİK ÇEKİÇ



AKD303

CAM ÇEKİCİ



AKD304

KESER



AKD305

VİDALI TOKMAK



AKD306

VİDALI TOKMAK



AKD307

VİDALI TOKMAK  
YEDEKLERİ



AKD400

Bİ METAL  
PANÇ SETİ



AKD401

AHŞAP  
PANÇ SETİ



AKD402

MERMER-GRANİT  
PANÇ



## HIRDAVAT ÜRÜNLERİ

### Profesyonel Çelik Şerit Metre



- Çift Stoplu
- Ergonomik Tasarım
- Darbeye Dayanıklı ABS Kasa
- Kemer Klipsi ve Taşıma Askılı (Metal)
- Uluslararası Ölçü Birimleri Uygunluğuna Sahip

KOD	ÖLÇÜ	ADET	KOLİ	FİYAT
JH-316W	3X16 mm	12	144	---
JH-516E	5x19 mm	12	96	---
JH-516X	5x25 mm	12	96	---
JH-1016X	10x25 mm	6	48	---

### Uni-Matic II Şerit Metre



KOD	ÖLÇÜ	ADET	FİYAT
UM II 2m	2 metre	14	---
UM II 3m	3 metre	14	---
UM II 5m	5 metre	10	---

### Alüminyum Su Terazisi (Mastarlı)



KOD	ÖLÇÜ	KOLİ	FİYAT
ST40	40 cm	60	---
ST50	50 cm	60	---
ST60	60 cm	60	---
ST80	80 cm	60	---
ST100	100 cm	60	---
ST120	120 cm	60	---

### Alüminyum Su Terazisi (Mıknatıslı)



KOD	ÖLÇÜ	KOLİ	FİYAT
STM40	40 cm	60	---
STM50	50 cm	60	---
STM60	60 cm	60	---
STM80	80 cm	60	---
STM100	100 cm	60	---
STM120	120 cm	60	---

### Mini Su Terazisi (Mıknatıslı)



KOD	ÖLÇÜ	KOLİ	FİYAT
MST23	23 cm	120	---

### Dijital Açılı Su Terazi



- Uzunluk : 40 cm
- Ampul Sayısı : 2
- Dijital Açı Ölçer
- LCD Ekran
- 0° ' den 180° ' ye kadar açı ölçümü
- Dikey ve yatay ampuller
- Anotlanmış alüminyum profil gövde
- ± 0.1° hassasiyet

### Marangoz Gönye Alüminyum



KOD	ÖLÇÜ	PK-KOLİ	FİYAT
MGA25	25 cm	12/120	---
MGA30	30 cm	12/48	---
MGA35	35 cm	12/48	---
MGA40	40 cm	12/48	---
MGA50	50 cm	12/48	---
MGA60	60 cm	12/48	---

## HIRDAVAT ÜRÜNLERİ



AKD600



AKD601



AKD602



AKD603

## MAKET BİÇAKLARI



AKD604



AKD605



AKD606



AKD607

İSKARPELA

CONTA MAKASI

SİNEKLİK FİTİL ÇEKME APARATLARI

MAKET BİÇAĞI  
YEDEĞİ



AKD500

KOMBİNE PENSE



AKD501

KARGABURUN



AKD502

YAN KESKİ



AKD503

TORNAVİDA SETİ



AKD505

YILDIZ TORNAVİDA



AKD504

DÜZ TORNAVİDA



AKD506

KONTROL KALEMİ



AKD507

ALLEN TAKIMI



AKD508

T TİPİ ALLEN



AKD509

DÜZ ANAHTAR TAKIMI



AKD510

KOMBİNE  
ANAHTAR TAKIMI



AKD511

SAC MAKASI

İZELTAS

# HIRDAVAT ÜRÜNLERİ

**TOMAX**



**Mercure®**

**ME MAKİNA TAKIM**



## SDS PLUS MATKAP UÇLARI

KOD	EBAT	Kutu/Koli Ad.
AKD700	4 X 110	25/200
AKD701	4 X 160	25/200
AKD702	5 X 110	25/200
AKD703	5 X 160	25/200
AKD704	5 X 260	25/200
AKD705	5,5 X 160	25/200
AKD706	5 X 210	25/200
AKD707	5,5 X 210	25/200
AKD708	6 X 110	25/200
AKD709	6 X 160	25/200
AKD710	6 X 210	25/200
AKD711	6 X 260	25/200
AKD712	6,5 X 160	25/200
AKD713	6,5 X 210	25/200
AKD714	6,5 X 260	25/200
AKD715	6 X 350	25/200
AKD716	7 X 110	25/200
AKD717	7 X 160	25/200
AKD718	7 X 210	25/200
AKD719	7 X 260	25/200
AKD720	7 X 350	25/100
AKD721	8 X 110	25/200
AKD722	8 X 160	25/200
AKD723	8 X 210	25/200
AKD724	8 X 260	25/200
AKD725	8 X 350	25/100
AKD726	9 X 110	25/200
AKD727	9 X 160	25/200
AKD728	9 X 210	25/200
AKD729	9 X 260	25/200
AKD730	10 X 110	25/200
AKD731	10 X 160	25/200
AKD732	10 X 210	25/200
AKD733	10 X 260	25/200
AKD734	10 X 300	25/100
AKD735	10 X 350	25/100
AKD736	10 X 450	25/100
AKD737	10 X 600	25/100
AKD738	11 X 160	25/200
AKD739	11 X 210	25/200
AKD740	11 X 260	25/200
AKD741	12 X 160	25/200
AKD742	12 X 210	25/200
AKD743	12 X 260	25/200
AKD744	12 X 300	25/100
AKD745	12 X 350	25/100

## SDS PLUS MATKAP UÇLARI

KOD	EBAT	Kutu/Koli Ad.
AKD746	12 X 450	25/100
AKD747	12 X 600	25/100
AKD748	13 X 160	25/200
AKD749	13 X 210	25/200
AKD750	13 X 260	25/100
AKD751	14 X 160	25/200
AKD752	14 X 200	25/100
AKD753	14 X 260	25/100
AKD754	14 X 300	25/100
AKD755	14 X 350	25/100
AKD756	14 X 450	25/100
AKD757	14 X 600	25/50
AKD758	15 X 160	25/200
AKD759	15 X 210	25/100
AKD760	15 X 260	25/100
AKD761	16 X 160	25/200
AKD762	16 X 200	25/100
AKD763	16 X 260	25/100
AKD764	16 X 350	25/100
AKD765	16 X 450	25/50
AKD766	16 X 600	25/50
AKD767	17 X 200	25/100
AKD768	18 X 200	25/100
AKD769	18 X 260	25/100
AKD770	18 X 350	25/50
AKD771	18 X 450	25/50
AKD772	18 X 600	25/25
AKD773	20 X 200	25/100
AKD774	20 X 260	25/50
AKD775	20 X 350	25/50
AKD776	20 X 450	25/25
AKD777	20 X 600	25/25
AKD778	22 X 260	25/50
AKD779	22 X 350	25/50
AKD780	22 X 450	25/25
AKD781	22 X 600	25/25
AKD782	24 X 350	25/25
AKD783	24 X 450	25/25
AKD784	24 X 600	25/25
AKD785	26 X 350	25/25
AKD786	26 X 450	25/25
AKD787	26 X 600	25/25
AKD788	28 X 450	25/25
AKD789	28 X 600	25/20

## HSS MATKAP UCU DIN 338 (SİYAH & BEYAZ)

KOD	EBAT	Kutu/Koli Ad.
AKD600	0,5 mm	100/5000
AKD601	1,0 mm	100/5000
AKD602	1,5 mm	100/5000
AKD603	2,0 mm	100/5000
AKD604	2,5 mm	100/5000
AKD605	3,0 mm	100/5000
AKD606	3,5 mm	100/4000
AKD607	4,0 mm	100/4000
AKD608	4,5 mm	100/2500
AKD609	5,0 mm	100/2000
AKD610	5,5 mm	100/2000
AKD611	6,0 mm	100/2000
AKD612	6,5 mm	50/1250
AKD613	7,0 mm	50/1250
AKD614	7,5 mm	50/1250
AKD615	8,0 mm	50/600
AKD616	8,5 mm	50/600
AKD617	9,0 mm	50/600
AKD618	9,5 mm	50/600
AKD619	10,0 mm	50/300
AKD620	10,5 mm	50/300
AKD621	11,0 mm	50/300
AKD622	11,5 mm	50/250
AKD623	12,0 mm	50/300
AKD624	12,5 mm	10/200
AKD625	13,0 mm	10/200
AKD626	13,5 mm	10/100
AKD627	14,0 mm	10/100
AKD628	14,5 mm	10/100
AKD629	15,0 mm	10/100
AKD630	15,5 mm	10/100
AKD631	16,0 mm	10/100
AKD632	16,5 mm	10/100
AKD633	17,0 mm	10/100
AKD634	17,5 mm	10/100
AKD635	18,0 mm	10/100
AKD636	18,5 mm	10/100
AKD637	19,0 mm	10/100
AKD638	19,5 mm	10/100
AKD639	20,0 mm	10/100

## HSS MATKAP UCU DIN 338 (SİYAH & BEYAZ)

KOD	EBAT	Kutu/Koli Ad.
AKD640	0,6 mm	100/5000
AKD641	0,7 mm	100/5000
AKD642	0,8 mm	100/5000
AKD643	1,1 mm	100/5000
AKD644	1,2 mm	100/5000
AKD645	1,3 mm	100/5000
AKD646	1,4 mm	100/5000
AKD647	1,6 mm	100/5000
AKD648	1,7 mm	100/5000
AKD649	1,8 mm	100/5000
AKD650	1,9 mm	100/5000
AKD651	2,1 mm	100/5000
AKD652	2,2 mm	100/5000
AKD653	2,3 mm	100/5000
AKD654	2,4 mm	100/5000
AKD655	2,6 mm	100/5000
AKD656	2,7 mm	100/5000
AKD657	2,8 mm	100/5000
AKD658	2,9 mm	100/5000
AKD659	3,1 mm	100/4000
AKD660	3,2 mm	100/4000
AKD661	3,3 mm	100/4000
AKD662	3,4 mm	100/4000
AKD663	3,6 mm	100/4000
AKD664	3,7 mm	100/4000
AKD665	3,8 mm	100/4000
AKD666	3,9 mm	100/4000
AKD667	4,1 mm	100/2500
AKD668	4,2 mm	100/2500
AKD669	4,3 mm	100/2500
AKD670	4,4 mm	100/2500
AKD671	4,6 mm	100/2500
AKD672	4,7 mm	100/2500
AKD673	4,8 mm	100/2500
AKD674	4,9 mm	100/2500
AKD675	5,2 mm	100/2000
AKD676	6,2 mm	100/2000
AKD677	6,7 mm	50/1250



# HIRDAVAT ÜRÜNLERİ



## YILDIZ BİTS UÇLAR

ÖLÇÜ	KUTU/ KOLİ	FİYAT
PH-1*25mm	60/2400	---
PH-2*25mm	60/2400	---
PH-3*25mm	60/2400	---
PH-1*50mm	30/1200	---
PH-2*50mm	30/1200	---
PH-3*50mm	30/1200	---
PH-1*75mm	20/800	---
PH-2*75mm	20/800	---
PH-3*75mm	20/800	---
PH-2*100mm	10/700	---
PH-1*150mm	10/500	---
PH-2*150mm	10/500	---
PH-2*200mm	10/400	---
PH-2*250mm	10/200	---
PH-2*300mm	10/200	---

## TORX BİTS UÇLAR

ÖLÇÜ	KUTU/ KOLİ	FİYAT
T-10*50mm	30/1200	---
T-15*50mm	30/1200	---
T-20*50mm	30/1200	---
T-25*50mm	30/1200	---
T-30*50mm	30/1200	---
T-40*50mm	30/1200	---
T-30*75mm	20/800	---
T-30*100mm	10/700	---
T-30*150mm	10/500	---

## MANYETİK SOMUN ADAPTÖRÜ

ÖLÇÜ	KUTU/ KOLİ	FİYAT
6*45mm	12 / 480	---
7*45mm	12 / 480	---
8*45mm	12 / 480	---
10*45mm	10 / 400	---
11*45mm	8 / 320	---
12*45mm	5 / 200	---
13*45mm	5 / 200	---
14*45mm	3 / 120	---

## YUVARLAK YILDIZ BİTS UÇLAR

ÖLÇÜ	KUTU/ KOLİ	FİYAT
PH-2*50mm	30/1200	---
PH-2*75mm	20/800	---
PH-2*100mm	10/700	---
PH-2*150mm	10/500	---

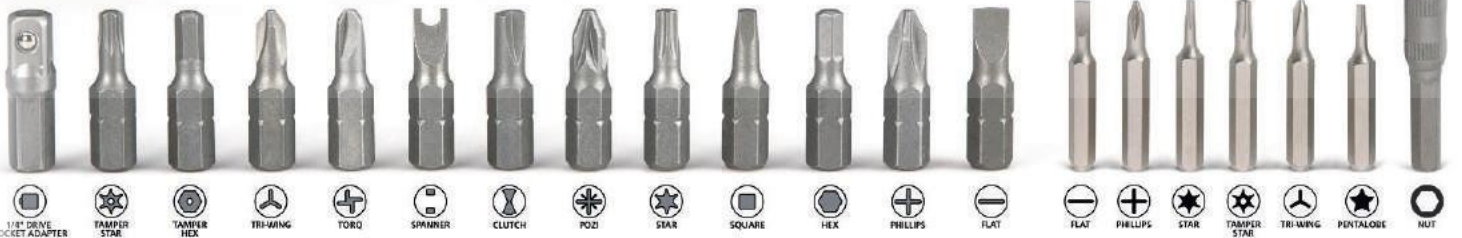

## HIRDAVAT ÜRÜNLERİ



INOX KESİCİLER



FLAP DİSKLER



INOX KESİCİLER



FLAP DİSKLER



KAYNAK ELEKTROD



PASLANMAZ KAYNAK TELİ

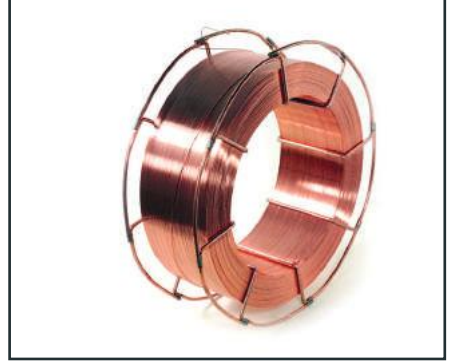

GAZ ALTI KAYNAK TELİ



KAYNAK MASKELERİ VE YEDEK CAM



TORÇ VE KAYNAK SARF ÜRÜNLERİ



## HIRDAVAT ÜRÜNLERİ



ELDİVEN



BARET



GÖZLÜK



MASKE



AYAKKABI



MAKARALI KABLO



UZATMA KABLO + KAUCUK FİŞ + PRİZ



ÇİFT TARAFLI BANT



KOLİ BANDI



MASKELEME BANDI



STREÇ FİLM



BALONLU NAYLON

■ Firmanıza özel Baskılı - Baskısız  
koli çeşitleri



ÖZEL ÖLÇÜLÜ KOLİ



KABLO BAĞI

# AKSESUARLAR

0 216 484 57 67

info@akadmakine.com

www.akadmakine.com.tr

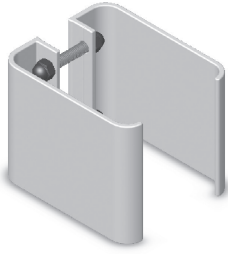
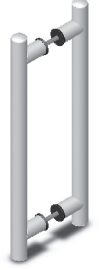
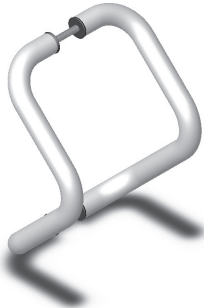
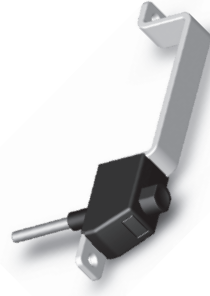
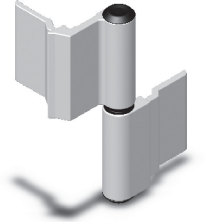
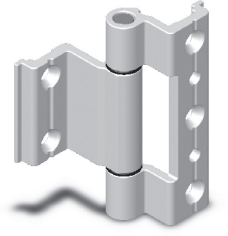
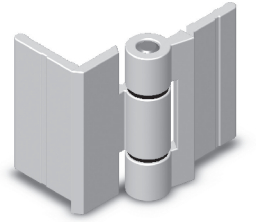
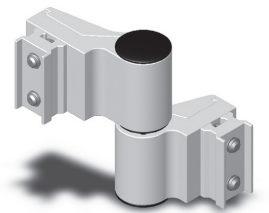

**KAPI KOLLARI****AA-258****AA-258-1****AA-262****AA-263****AA-261****BORU KOLLARI****AA-850-1****AA-850****AA-850-K****V BÜKME  
KOLLAR****YARIMAY  
BÜKME KOLLAR****PENCERE KOLLARI****AA-278****AA-278-1****AA-279****AA-272-1****İKAR****MENTEŞELER****AA-168****AA-164****AA-166****AA-162****AA-163**

## SÜRGÜLER



AA-399



AA-399-1



AA-397

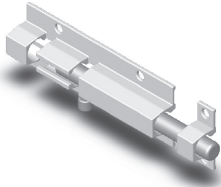

AA-398

 **IKAR**

## AKSESUARLAR



AA-371

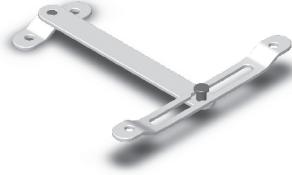

AA-375



AA-374



AA-369-D



AA-369-M



AA-372



AA-1000



AA-1001



AA-1002



AA-1003



AA-MS0204



AA-MS0201



AA-MS0200





' Daima Birlikte '

Ürün Çeşitleri ve Detaylı Bilgi için Web Sitemizi Ziyaret Edebilirsiniz ;

[www.akadmakine.com.tr](http://www.akadmakine.com.tr)



Online Whatsapp Destek Hattımız Artık Hizmetinizde ;



+90 534 085 03 13

#### İletişim Bilgilerimiz

Saadet ALAGÖZ  
+90 216 484 57 67  
saadet@akadmakine.com  
info@akadmakine.com

Fatih AKTÜRK  
+90 551 395 63 62  
fatih@akadmakine.com  
info@akadmakine.com



# AKAD MAKİNE

' Daima Birlikte '



SCHWERT



freud.



+90 216 484 57 67



info@akadmakine.com



www.akadmakine.com.tr



+90 534 085 03 13



AKAD MAKİNE TİCARET LİMİTED ŞİRKETİ  
Altınşehir Mh. Sazlı Sk. No:17/A  
Ümraniye / İstanbul